

# SQUADRO

## wallwasher trim

[xal.com/squadro](http://xal.com/squadro)

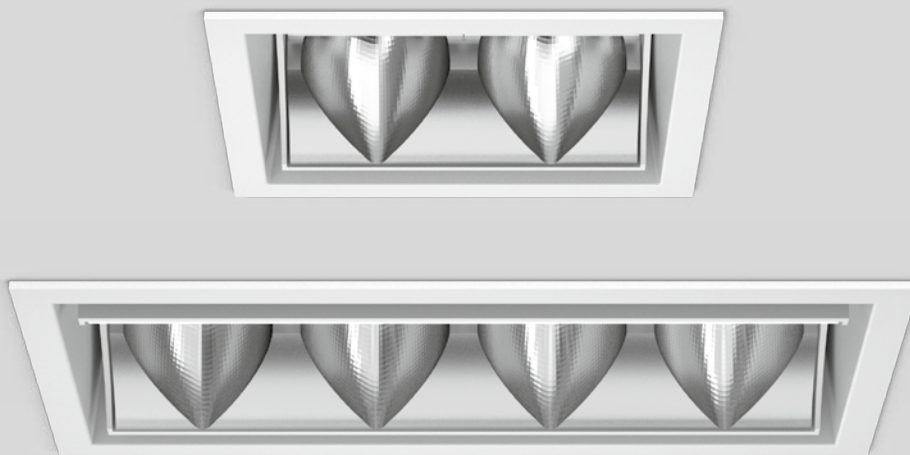

### Quickinfo

#### GENERAL

recessed with trim  
IP20, IP40  
quick installation

#### LED

COB LED module  
up to 14240lm  
up to 117lm/W  
3000K, 4000K  
CRI ≥ 80  
Binning initial ≤ 3 MacAdam

#### ESTIMATED LED LIFETIME

L80/50000h

#### OPTICAL

asymmetric illumination  
PC/aluminium coated reflector  
shelf/wall floor washer

#### ELECTRICAL

220–240V  
non DIM, DIM DALI

#### PHYSICAL

aluminium  
powder-coated  
white

### Description

**DE** Deckeneinbaustrahler aus Aluminiumdruckguss in 2 Größen, in verschiedenen Varianten (2-flammig, 4-flammig bzw. 2 × 4-flammig) und mit 2 verschiedenen Lichtmodulen (für shelf floor washer und wall floor washer); mit umlaufendem Rand; Oberfläche weiß pulverbeschichtet; werkzeuglose Montage mittels Schnappfederverschluss; Gangzonenstrahler mit speziellen Multi-Freiformflächenreflektoren mit Facettenoptik zur äußerst präzisen Lichtlenkung; punktgenaue Regal- und Gangzonenausleuchtung, optimale Längsentblendung für hohen Sehkomfort in der Gangzone, einstellbare Lichtmodule mit Verriegelung; (+20° bis -15° schwenkbar, Variante double-sided output: maximaler Schwenkbereich für eine Seite einstellbar); Kühlkörper in Leuchtegeometrie für optimales Thermomanagement und passive Kühlung der LEDs integriert; COB (Chip on Board) Technologie für höchste Effizienz; energieeffiziente LEDs mit sehr guter Farbwiedergabe; Binning initial ≤ 3 MacAdam; lieferbar in den Lichtfarben 3000K und 4000K; CRI ≥ 80; min. 80% des Lichtstromes nach 50 000 h Lebensdauer Schutzart IP20; IP40-Schutzglas als Zubehör erhältlich; SK II; optional DALI-dimmbar

**EN** Recessed ceiling spotlight in die cast aluminium in 2 sizes, in different types (2 lamps, 4 lamps or 2 × 4 lamps) and with 2 types of light modules (for shelf floor washer and wall floor washer); with trim; surface white powder coated; installation without tools using snap spring closure; aisle spotlight with special, multi-free-form, facet effect surface reflectors for high precision light control; precise shelf and aisle zone lighting, optimum longitudinal glare control for high viewing comfort in the aisle zone, adjustable light modules with interlock; (tiltable from +20° up to -15°, double-sided output variant: maximum swivel range adjustable for one side); heat sink integrated into luminaire geometry for optimum thermal management and passive cooling of LEDs; COB (Chip on Board) technology for maximum efficiency; energy-efficient LEDs with very good colour rendering; binning initial ≤ 3 MacAdam; available in the light colours 3000K and 4000K; CRI ≥ 80; min. 80% of the luminous flux after 50 000 hours; protection class IP20; IP40 protection glass available as an accessory; PC II; optional DALI dimmable

### Features

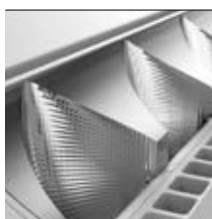

microfaceting



+20° up to -15° tiltable

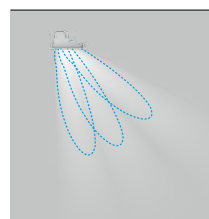

adjustable light module

### Standard configuration

**COLOUR TEMPERATURE** ◆◆  
3000K 5

**CONTROL** ◆◇  
non DIM 1

**MATERIAL COLOUR**  
white

**REFLECTOR** ▲  
shelf floor washer S  
wall floor washer A  
1x shelf / 1x wall floor washer\* B

\*only for 2x4 lamps

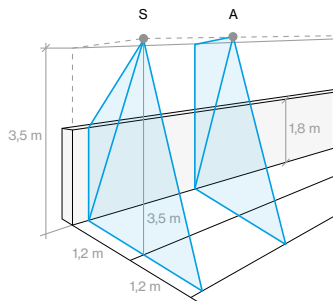

### Extended configuration

**COLOUR TEMPERATURE** ◆◆  
4000K 6

**CONTROL** ◆◇  
DIM DALI 3

#### LIGHT DISTRIBUTION 4 LAMPS

shelf floor washer

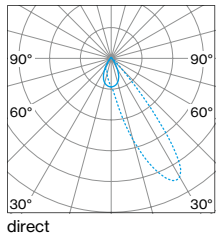

wall floor washer

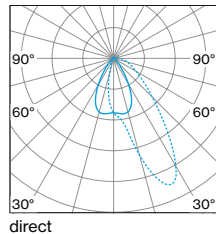

#### LIGHT DISTRIBUTION 2x4 LAMPS

shelf floor washer

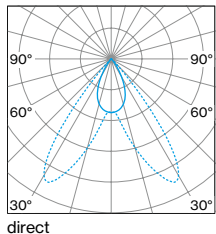

wall floor washer

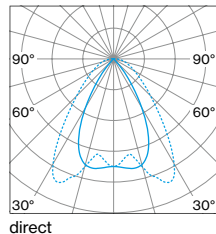

1x shelf / 1x wall floor washer

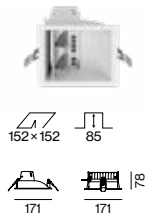
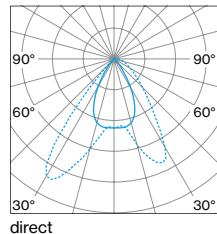

### SQUADRO 1x2 lamps, wallwasher, trim

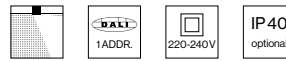

SYSTEM POWER	COLOUR TEMP.	LUMINOUS FLUX	ORDER CODE
30W	3000K	3410lm	0 4 9 - 2 0 1 1 <span style="color: blue;">◆◆</span> 7 ▲
	4000K	3560lm	



### SQUADRO 1x4 lamps, wallwasher, trim

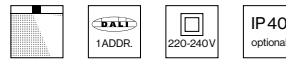

SYSTEM POWER	COLOUR TEMP.	LUMINOUS FLUX	ORDER CODE
61W	3000K	6830lm	0 4 9 - 2 0 3 1 <span style="color: blue;">◆◆</span> 7 ▲
	4000K	7120lm	

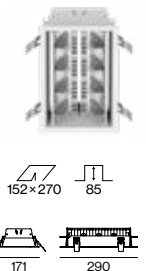

### SQUADRO 2x4 lamps, wallwasher, trim

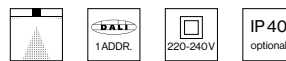

SYSTEM POWER	COLOUR TEMP.	LUMINOUS FLUX	ORDER CODE
2x44W	3000K	2x5310lm	0 4 9 - 2 0 4 0 <span style="color: blue;">◆◆</span> 7 ▲
	4000K	2x5540lm	
2x61W	3000K	2x6830lm	0 4 9 - 2 0 4 1 <span style="color: blue;">◆◆</span> 7 ▲
	4000K	2x7120lm	

### Optical accessories

#### IP40 PROTECTION GLASS

TYPE	ORDER CODE
2 lamps / single-sided output	0 4 9 - 2 9 1 0 0 1 0
4 lamps / single-sided output	0 4 9 - 2 9 3 0 0 1 0
2x4 lamps / double-sided output	0 4 9 - 2 9 4 0 0 1 0

### Technical data

#### SQUADRO 4 lamps, wall shelf washer, trim, 61W, 3000K

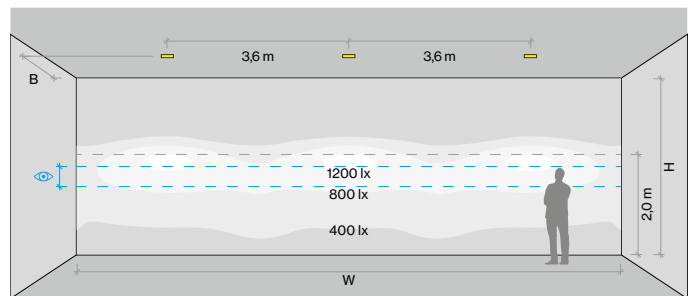

#### SQUADRO 4 lamps, wall floor washer, trim, 61W, 3000K

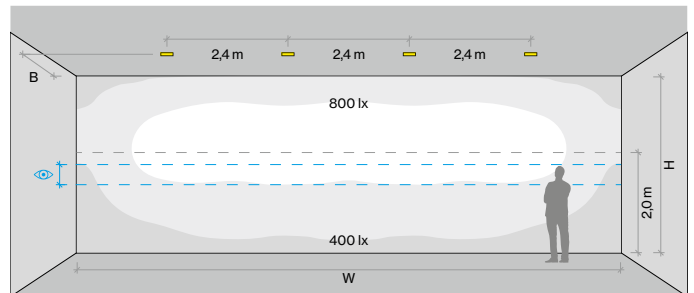

ROOM VALUES	CALCULATION SURFACE
Wall dimensions H = 3.5m   W = 10.8m	Surface dimensions 10.8x3.5m
Distance to wall B = 1.3m	Surface height 0 - 3.5m
Aisle width 2.6m	
Reflection factor 0.7   0.7   0.2	Eye level <span style="color: blue;">👁</span> 1.35m - 1.75m
Maintenance factor 0.9	